

Maio/2010

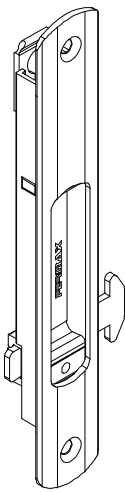

**FEC 16 manual**  
**FEC 37 trava autom.**

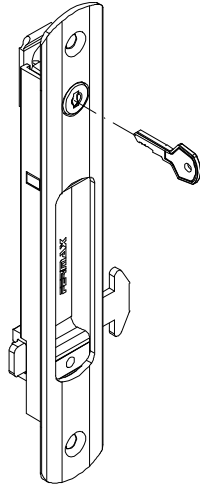

**FEC 19 manual**  
**FEC 38 trava autom.**

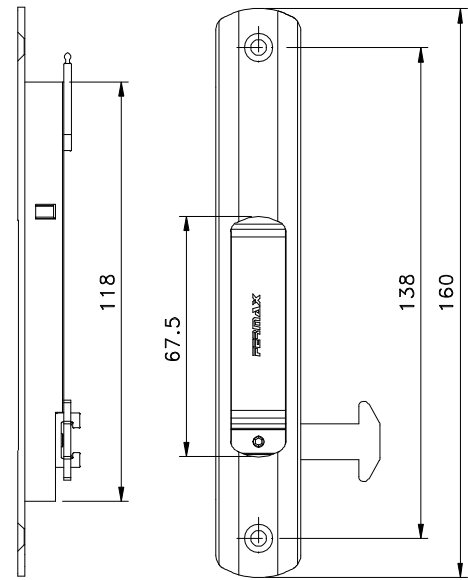
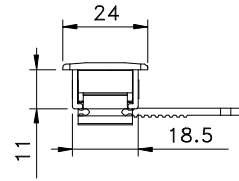

Vistas - escala 1:2

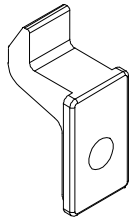

**CFE 22**

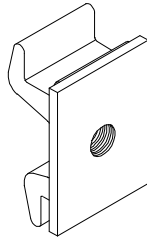

**CFE 23**

Contra-fecho lateral  
escala 1:1

Contra-fecho central  
escala 1:1

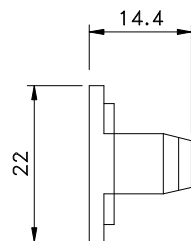
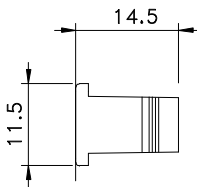
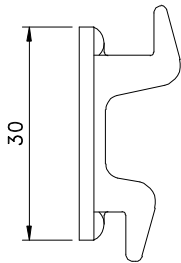
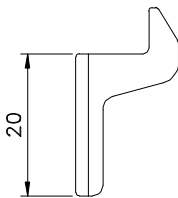

contra-fecho lateral

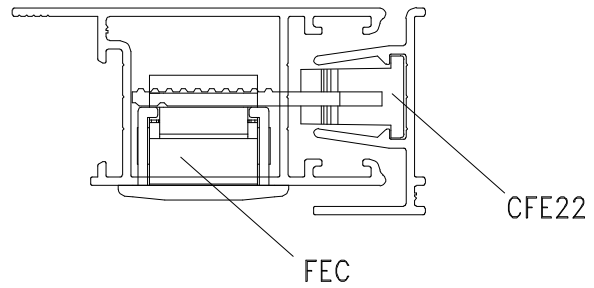

contra-fecho central

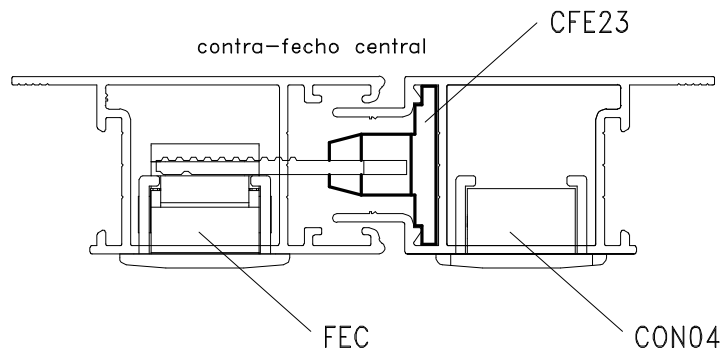

Instalação - escala 1:1

Medidas em milímetros

**Composição**

- Estrutura alumínio
- Lingueta/parafusos inox
- Mola aço (FEC37/38)
- Chave cromada (FEC19/38)